

472

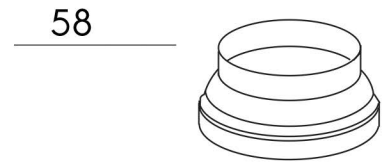

122



58

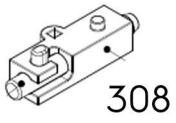

308

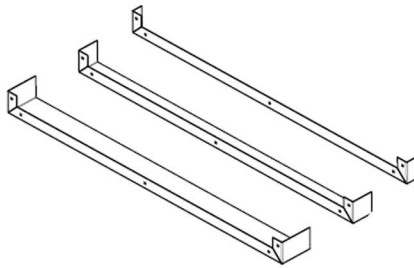

309C  
309B  
309A

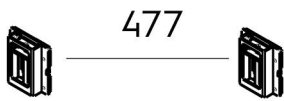

477

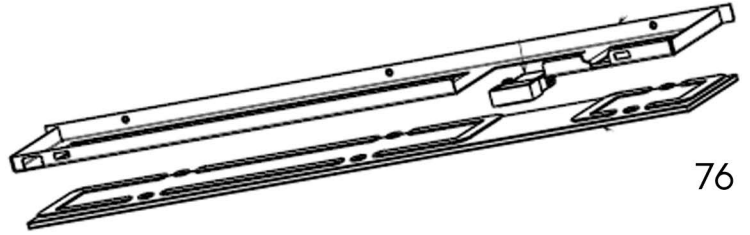

76

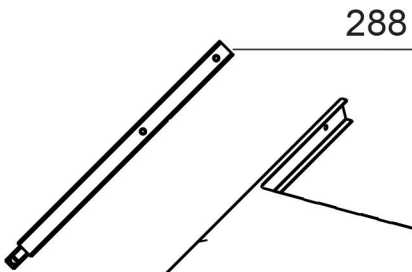

288

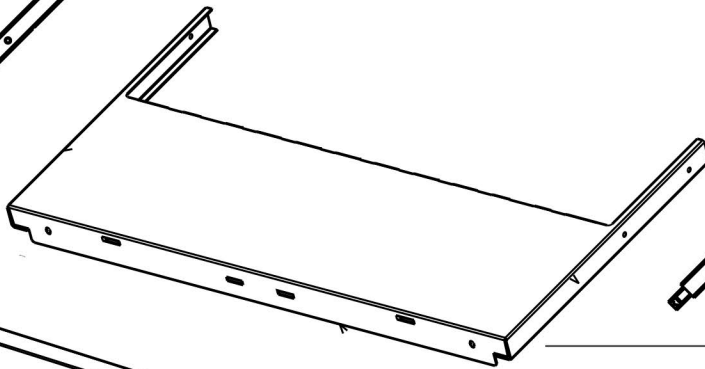

84

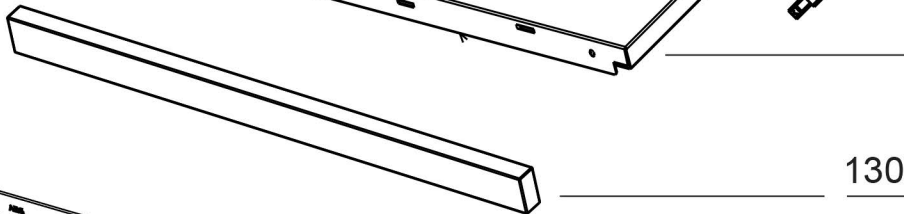

130

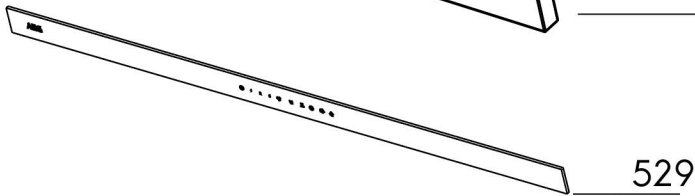

529



474

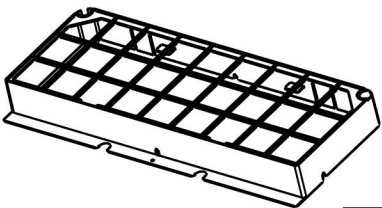

547

9

